



Takumi Connector

TKM / TKM6F

Operation Manual

Surpass Industry Co., Ltd.

Before You Use

WARNING

Confirm the compatibility of the type of fluid to be used and the wetted material of this product before using it.

Before using this product, carefully read this instruction manual to learn the correct usage.

Keep this manual at hand to see it any time you need.

Follow the correct usage of this product specified in this manual.

Comply with the statements of warning described in this manual.

The above instructions are mandatory. Neglecting these instructions may result in personal injury or accidents.

<About Instruction Manual>

The information described in this manual is subject to change without prior notice, due to improvements of product in performance and/or functionality.

No parts of this manual may be reproduced or utilized in any form or by any means.

Please download the electronic manual from our homepage in case that you lost this manual.

Every effort was made to ensure that all information included in this manual was complete and accurate at the time of printing. However, if you have any point of doubt, errors, or omissions, please contact Surpass Industry.

<Call to:>

SURPASS

Surpass Industry Co., Ltd.

2203 Shimooshi, Gyoda-shi, Saitama 361-0037 Japan

Tel.: +81 48 554 9760 Fax.: +81 48 554 9906

URL : <http://www.surpassindustry.co.jp>





©2004-2012 Surpass Industry Co.,Ltd. All rights reserved.

○ Important Safety Instructions

About Marks Used

Warnings and cautionary notes are provided in this manual to ensure this product is used correctly and to prevent personal injury and property damage. The meanings of the WARNING and CAUTION symbols in this manual are as described below. Read and understand these notes before reading the rest of this manual.

In particular, fully understand and obey the instruction of **DANGER** mark.

 DANGER	This symbol indicates warnings against impending danger which, if not observed, may cause death or severe injury to the user.
 WARNING	This symbol indicates warnings which, if not observed, may cause death or severe injury to the user.
 CAUTION	This symbol indicates warnings which, if not observed, may physically impair the user or damage surrounding objects.
	Provides important notices and indications to operate the product correctly.

DANGER/WARNING and CAUTION statements

Before use of this product, carefully read the statements of DANGER and WARNING marks and comply with them.

Instructions on Installing

**DANGER****This is Mandatory Rule!!**

Whenever using this product for hazardous chemical fluids or solvents, wear anti-chemical protective gear (protective gloves, protective mask, and protective clothing) that completely protects your body. Exposure of chemical fluids may result in personal injury.

**WARNING**

Follow the procedures provided in this manual when attaching the plug and socket and piping the connector. An improper way or wrong procedure may cause an accident such as liquid leakage, resulting in personal injury.

When connecting a male thread, make sure the female thread of this connector is of PT or NPT. Connecting a wrong type of male thread may cause liquid leakage, resulting in personal injury.

Follow the correct procedure when attaching a taper thread. An improper way or wrong procedure of attaching may cause liquid leakage, resulting in personal injury.

Instructions on Handling

**WARNING**

Be careful not to damage the contacting part (sealing part) of the plug and socket. Damage in the contacting part may cause liquid leakage, resulting in personal injury.

Keep this product from contacting with anything rigid since it is made of resin materials and subject to breakage. Any breakage of the product may cause liquid leakage, resulting in personal injury.

Instructions on Mounting



DANGER

This is Mandatory Rule!!

Release pressure from the piping before attaching/detaching the connector. A pressurized condition may cause spouting of chemicals, resulting in personal injury.

Always wear anti-chemical protective gear (protective gloves, protective mask, and protective clothing) that protects your entire body when attaching/ detaching the connector. A contact with chemicals may cause personal injury.

Attach/detach the connector in a clean place with no dust. Degradation of sealing performance due to adhesion of dust may cause liquid leakage, resulting in personal injury.

Always attach/detach the connector at right angle to the surface of container. Attaching/detaching the connector at an angle may cause spouting of chemicals, resulting in personal injury.

Do not apply the connector to rotary joint or other rotary application. Lower tackiness caused by the wrong application may result in personal injury due to leakage of chemical fluids.

When the connector is connected, make sure that the connector is fully connected. The chemicals may splash and personal injury may be caused.

Use out of the operating pressure range may result in slip-off. Be sure to use within the operating pressure range.



- Apply operating fluid or pure water to the O-Ring of the socket (inner) or O-Ring sliding part of the plug (sealing part) when connecting the socket or plug to prevent the O-Ring from being damaged and to reduce the slide resistance (insertion load).
- Do not use abrasive compound or fluid that is easy to clot as they may impair normal function.

Instructions on Maintenance and Inspection



CAUTION

Surpass Industry is not be liable to any failure or leakage of the product due to O-Ring replacement and/or disassembly performed by any parties other than Surpass Industry.

If you are not confident of success in maintenance work, please call Surpass Industry.

1. Description of the Product

The TAKUMI connector series, developed to meet various needs, is applicable to high-purity chemicals used in semi-conductor manufacturing processes. This product range of one-touch attachable connectors has an excellent record of performance over years. To apply wide range of chemicals, this series has achieved quality improvements in chemical resistance, leakage control, and reduction of particles, etc.

Features

- The special connection mechanism is implemented, which eliminates liquid drops when detaching.
- All parts in contact with liquid are made of fluorine resin.
- The automatic stop-valve is adopted to inhibit particles to come into the connector when attached and detached, which facilitates the attaching/detaching procedure.
- Surpass original connecting method enables the connector to be attached with a single push.
- To eliminate the possibility of liquid leakage, the automatic stop-valve is designed without an O-ring.
- The combination of TKM-3P and TKM-3S does not have function for prevention of liquid drop.



Do not use abrasive compound or fluid that is easy to clot as they may impair normal function.

2. Specifications

TKM TYPE

Operating Fluid Pressure	: 0 ~ 350 kPa (50.75 psi)
Withstanding Pressure	: 400 kPa (58 psi)
Operating Environmental Temperature	: 5 ~ 60 (41 ~ 140 °F)
Operating Fluid Temperature	: 5 ~ 70 (41 ~ 158 °F)
Wetted parts	: PCTFE, PTFE, PFA, O RING (Depends on the material.)

TKM6F TYPE

Operating Fluid Pressure	: 0 ~ 250 kPa (36.25 psi)
Withstanding Pressure	: 300 kPa (43.5 psi)
Operating Environmental Temperature	: 5 ~ 50 (41 ~ 122 °F)
Operating Fluid Temperature	: 5 ~ 60 (41 ~ 140 °F)
Wetted parts	: PTFE, PFA, O RING (Depends on the material.)

3. Outside Dimensions

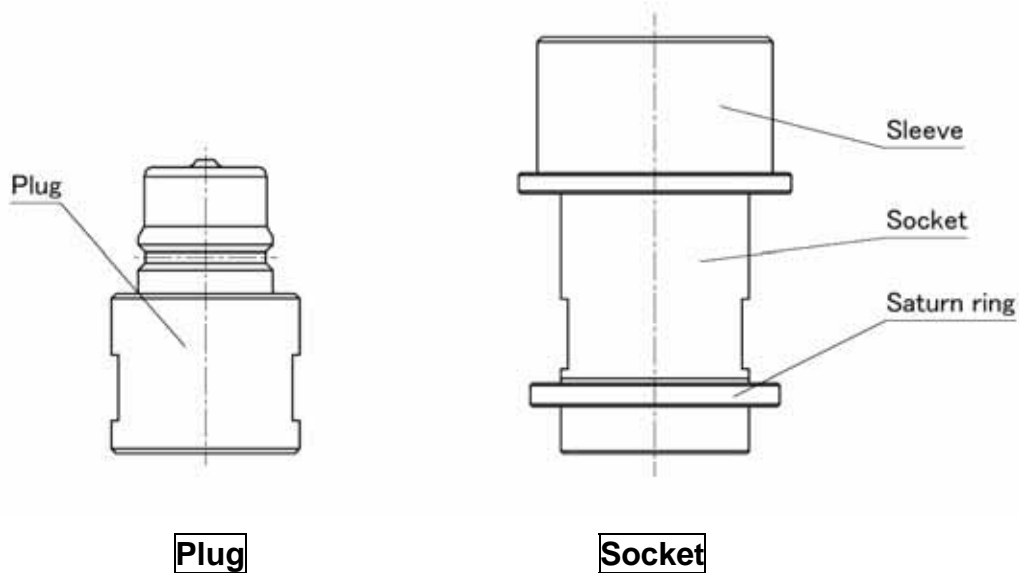

4. Installation

**DANGER****This is Mandatory Rule!!**

Whenever using this product for hazardous chemical fluids or solvents, wear anti-chemical protective gear (protective gloves, protective mask, and protective clothing) that completely protects your body. Exposure of chemical fluids may result in personal injury.

4-1 Unpacking

Be careful not to damage the plug and socket when unpacking.

4-2 Installation site

- Do not install the product where any bending or tensile stress is applied to the connector.
 - Do not use the product where it may be influenced by excessive vibration or impact.
-

4-3 Attaching the taper thread

Wrap the PTFE sealing tape around an appropriate paired joint (male thread) of the female thread three or four times.



WARNING

Follow the procedures provided in this manual when attaching the plug and socket and piping the connector. An improper way or wrong procedure may cause an accident such as liquid leakage, resulting in personal injury.

When connecting a male thread, make sure the female thread of this connector is of PT or NPT. Connecting a wrong type of male thread may cause liquid leakage, resulting in personal injury.

Follow the correct procedure when attaching a taper thread. An improper way or wrong procedure of attaching may cause liquid leakage, resulting in personal injury.



- The female thread can be used for tubing. As the paired male thread, use the taper male.
 - Use the male thread that is made of materials such as PTFE, PCTFE, PFA, PE, and PP, but not made of rigid materials like metal.
 - Whenever using the female thread, wind it with PTFE seal-tape three or four times and tighten it.
-

5. Usage

**DANGER****This is Mandatory Rule!!**

Release pressure from the piping before attaching/detaching the connector. A pressurized condition may cause spouting of chemicals, resulting in personal injury.

Always wear anti-chemical protective gear (protective gloves, protective mask, and protective clothing) that protects your entire body when attaching/ detaching the connector. A contact with chemicals may cause personal injury.

Attach/detach the connector in a clean place with no dust. Degradation of sealing performance due to adhesion of dust may cause liquid leakage, resulting in personal injury.

Always attach/detach the connector at right angle to the surface of container. Attaching/detaching the connector at an angle may cause spouting of chemicals, resulting in personal injury.

Do not apply the connector to rotary joint or other rotary application. Lower tackiness caused by the wrong application may result in personal injury due to leakage of chemical fluids.

When the connector is connected, make sure that the connector is fully connected. The chemicals may splash and personal injury may be caused.

Use out of the operating pressure range may result in slip-off. Be sure to use within the operating pressure range.



- Apply operating fluid or pure water to the O-Ring of the socket (inner) or O-Ring sliding part of the plug (sealing part) when connecting the socket or plug to prevent the O-Ring from being damaged and to reduce the slide resistance (insertion load).
 - Do not use abrasive compound or fluid that is easy to clot as they may impair normal function.
-

5-1 Attaching procedure

Confirm that the piping is depressurized (with no pressure applied).



DANGER

This is Mandatory Rule!!

Release pressure from the piping before attaching the connector. A pressurized condition may cause spouting of chemicals, resulting in personal injury. Connect the tube without any moment or tension to bend the joint portion.

Hold the Saturn ring of the socket (See the photo and Figure 1 below).



Do not pull the socket's sleeve when attaching to the plug, or they cannot be connected.

A good example

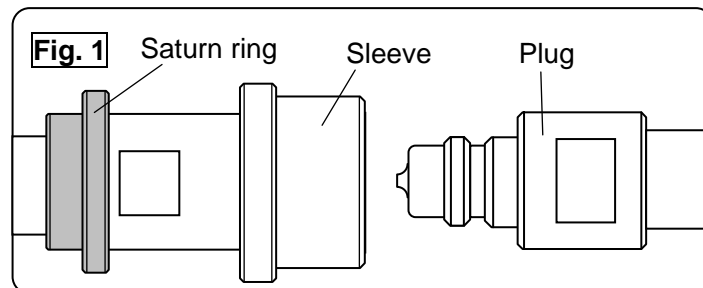
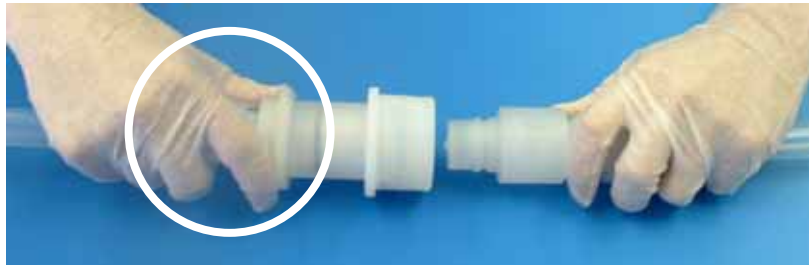

A bad example

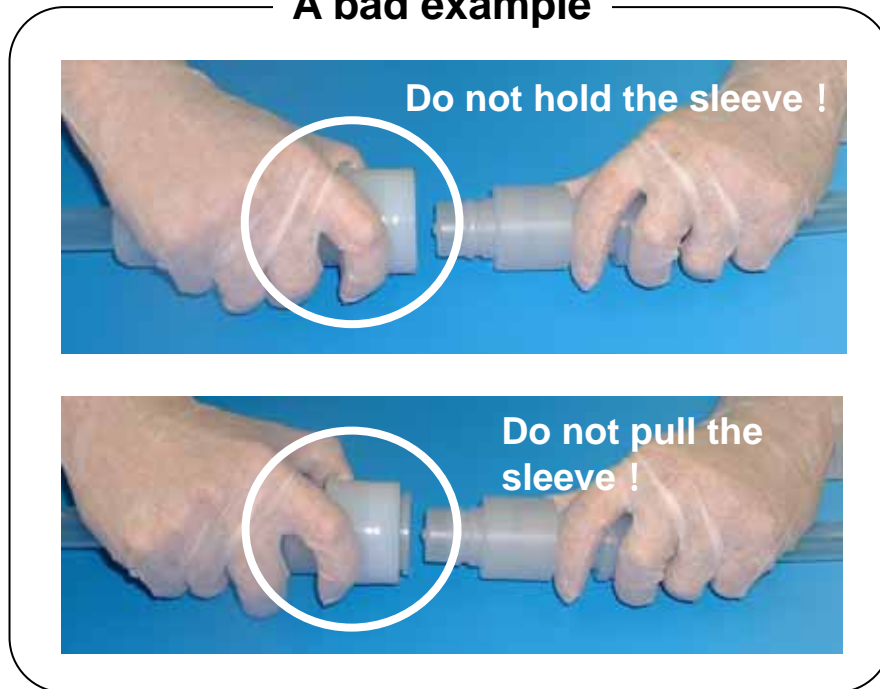

Holding the Saturn ring, insert the socket straight into the plug (See the photo and Figure 2 below).

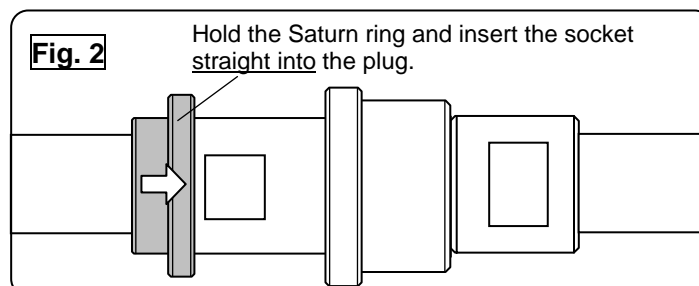
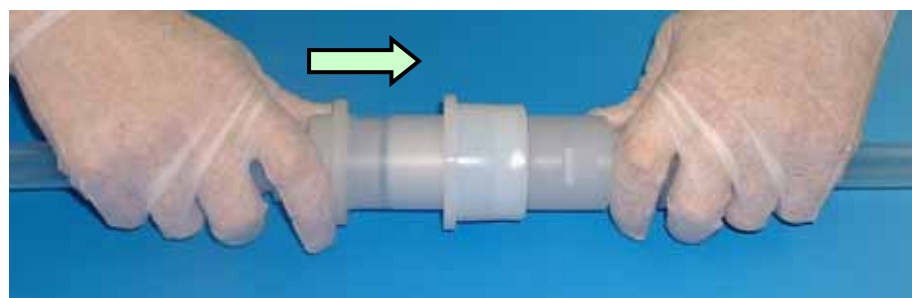

Confirm that the plug and socket are securely connected
(See the photo and Figure 3 below).

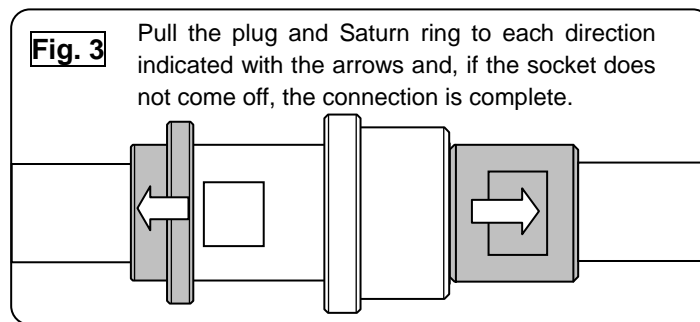
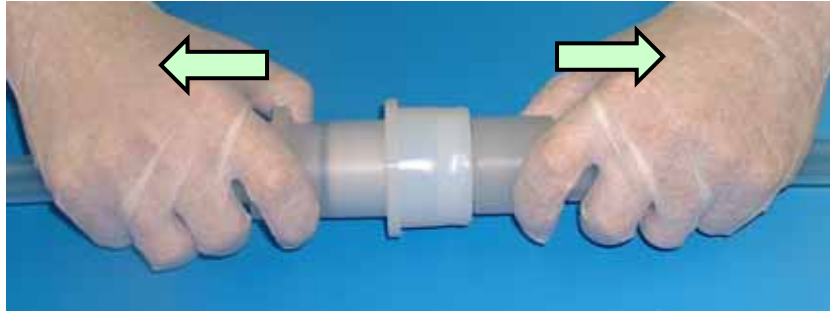

A bad example

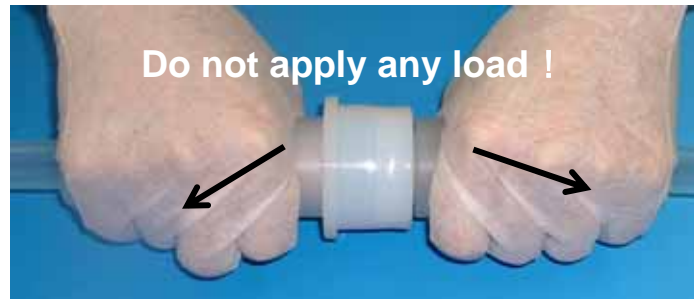

5-2 Supplying liquid

After confirming the connection is securely made, start supplying liquid.

5-3 Detaching procedure

Make the piping depressurized (no pressure applied).



DANGER

This is Mandatory Rule!!

Release pressure from the piping before attaching the connector. A pressurized condition may cause spouting of chemicals, resulting in personal injury.

Connect the tube without any moment or tension to bend the joint portion.

Pulling in the sleeve of the socket, pull out the entire socket without making any angle (See the photo and Figures 4 and 5 below).

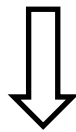

A bad example

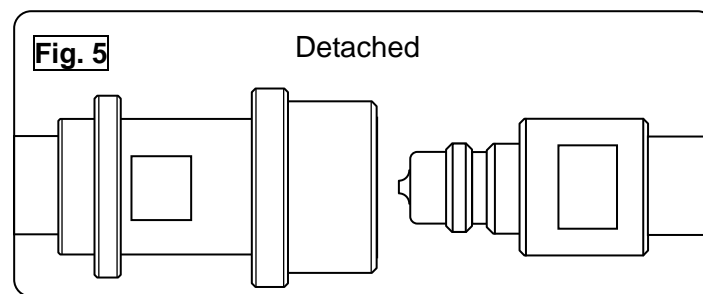
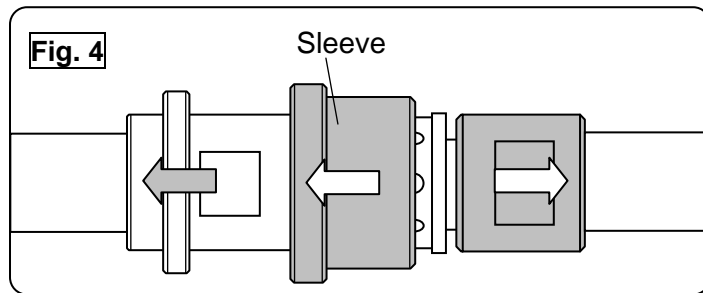

6. Maintenance and Inspection

 **CAUTION**

Surpass Industry is not be liable to any failure or leakage of the product due to O-Ring replacement and/or disassembly performed by any parties other than Surpass Industry.

If you are not confident of success in maintenance work, please call Surpass Industry.

6-1 Periodic inspection

Inspect the product at appropriate intervals (at least once a year) depending on your usage. If the inspection detects any abnormality, contact Surpass Industry for maintenance work.

6-2 Daily inspection

Inspect the following items every day before and after the operation. Whenever the inspection detects any abnormality, take a corrective action.

- Adhesion of coarse particles, dust or dirt.
 - Liquid leakage from the piping or connecting part.
 - Looseness of bracket
 - Liquid leakage from the O-ring part
-

7. Troubleshooting

Trouble Condition	Checking Points	Correcting Action
Connection cannot be made.	You are pulling the socket's sleeve when attaching to the plug. The size of the plug does not match the socket.	Attach the socket to the plug without pulling its sleeve. Connect the plug and socket of the same size.
Liquid does not flow.	The socket is not securely attached. The piping is not pressurized.	Insert the socket completely into the plug. Apply the appropriate pressure to the piping.
The socket cannot be detached.	The piping is pressurized. You are trying to detach the socket from the plug without pulling its sleeve.	Depressurize the piping. Pull the socket's sleeve when pulling it out from the plug.

Notify your nearest sales office for problems not listed above.

8. Product Warranty

The warranty runs for one year after the day when Surpass Industry products are delivered from Surpass factory in Japan. In case Surpass Industry should agree in writing that the defects in performance or material were caused by faulty design or workmanship of Surpass Industry, replacement products will be supplied free of charge. This warranty shall not be applied to any defects caused by misuse, alteration, neglectful treatment, and neglect of our recommendations or instructions.

In addition, we are not be liable to any direct or consequential loss, damage, and personal injury due to an unauthorized usage in combination with other products and an improper usage outside of the specifications. Our product warranty shall be limited to replacement of product.

Replacement with expense to the purchaser shall be applied to the followings:

- Any defective products caused by usage that is not described in the Instruction Manual.

- Any defective products caused by neglectful treatment.

- Any defective products caused by decomposition, alteration, and improper adjustment or repair.

- Any defects of products caused by acts of God including natural disaster or fires.

- Consumables and accessories.

<Call to:>

SURPASS

Surpass Industry Co., Ltd.

2203 Shimooshi, Gyoda-shi, Saitama 361-0037 Japan

Tel.: +81 48 554 9760 Fax.: +81 48 554 9906

URL : <http://www.surpassindustry.co.jp>

©2004-2012 Surpass Industry Co.,Ltd. All rights reserved.
