



# Fluorine Resin Type Pressure Sensor with Display

## PTCD

## PTTD

## CSD

Operation Manual

Surpass Industry Co., Ltd.

## Read Before Use

- Before using this product, check the compatibility of the type of liquid to use and the wetted parts material in this product.
- All users are required to carefully read and understand this manual before operation of the product.
- Keep this manual in good condition and close at hand for quick reference whenever necessary.
- Use the product only as intended, and only as directed in this manual.
- Cautionary notes in this manual must be fully understood and complied with at all times.



## About This Operation Manual

- The contents of this manual are subject to change without prior notice, due to improvements in product functionalities and / or performance.
- No part of this manual may be reproduced in any form or by any means.
- Although this manual has been prepared with all possible care, please do not hesitate to contact Surpass Industry about errors, omissions, or any other points of doubt.



## Important Safety Instructions

### <Symbols in This Operation Manual>

**Warnings and cautionary** notes are provided in this manual to ensure this product is used correctly and to prevent personal injury and property damage. The meanings of the WARNING and CAUTION symbols in this manual are as described below. Read and understand these notes before reading the rest of this manual.

 <b>DANGER</b>	This symbol indicates warnings against impending danger which, if not observed, may cause death or severe injury to the user.
 <b>WARNING</b>	This symbol indicates warnings which, if not observed, may cause death or severe injury to the user.
 <b>CAUTION</b>	This symbol indicates warnings which, if not observed, may physically impair the user or damage surrounding objects.

## Specific Warnings

 <b>WARNING</b>	 <b>WARNING</b>
<ul style="list-style-type: none"> <li>● This product is not explosion-proof. Never use it with flammable fluids such as solvents. Doing so may cause fire and or explosion and is highly dangerous.</li> <li>● Never use with <u>gas-permeable liquids (hydrofluoric acid, hydrochloric acid, nitric acid, ozone, etc.)</u>. Gas permeation may lead to product failure.</li> <li>● Never disassemble or alter the product. Doing so will cause breakage of the product and possible liquid leakage. The use of dangerous chemicals, solvents, and gases may cause physical impairment.</li> <li>● Do not apply more pressure than the allowed maximum output. Doing so will cause product failure and possible liquid leakage. The use of dangerous chemicals, solvents, and gases may cause physical impairment.</li> <li>● Do not insert screwdrivers, wires, or other objects into the connector parts. Doing so will cause product failure and possible liquid leakage. The use of dangerous chemicals, solvents, and gases may cause physical impairment.</li> <li>● Refrain from excessive pulling or bending of the cables. Doing so may cause wiring disconnections, which may cause electrical shock and fire hazards.</li> <li>● Install the pressure sensor in an area that is dry and clean. Supply power to the pressure sensor from an isolation transformer (switching power supply) rated for 24 VDC or less. Make sure the rated power output is 150 VA and does not exceed 2A. (Use exclusively for class 2 circuits)</li> </ul>	<ul style="list-style-type: none"> <li>● When mounting connector parts, comply with the instructions issued by each connector manufacturer. Loose connections may result in disconnection or chemical leakage. The use of dangerous chemicals, solvents, and gases may cause physical impairment.</li> <li>● Do not use the product in areas where corrosive gases are being ejected. Corrosion in the pressure sensor and connector may result in liquid leakage. The use of dangerous chemicals, solvents, and gases may cause physical impairment.</li> <li>● Obey these instructions. <ul style="list-style-type: none"> <li>- Refrain from excessive tightening of the connector parts.</li> <li>- Do not install the product in areas of excessive vibration or shock.</li> <li>- Use the product only within the specified operating environment. Otherwise, damage to the pressure sensor and connector may occur and result in liquid leakage. The use of dangerous chemicals, solvents, and gases may cause physical impairment.</li> </ul> </li> <li>● Protect all wiring used by providing support along the wiring at appropriate distances.</li> <li>● For shielded cables, peel the sheath at the very end of the cable and connect the shield to the chassis or mounting plate, etc., using the proper tool (recommended tool: Nitto Supply AL-2).</li> </ul>

## Product Description

### <Applications>

PTFE Pressure Sensors can be used as semiconductor manufacturing devices or as pressure monitor/process control devices for chemical processes, high-purity fluids, etc.

### <Features>

- All models comply with the RoHS directive.
- The wetted part is fully made of fluorine resin allowing it be used in clean-room applications.
- Because PTFE Pressure Sensors use strain gauges, they offer you excellent reliability and durability.
- Zero adjust is easily done in the field. Simply press the UP and DOWN buttons simultaneously.
- The sensor features a built-in 3-digit display unit, upper and lower limit outputs (x 2), and an analog output (current, voltage).

## Specifications

Model	PTCD	CSD	PTTD
Type	Inline type	Straight type	Inline type
Standard Rated Pressure Range	0 to 500kPa (see nameplate)		
Withstanding Pressure	150% of Rated Pressure Range (for 0 to 700kPa, the withstand pressure is 800kPa)		
Pressure Type	Gauge Pressure		
Applicable Fluid	Liquids and gases that do not corrode nor permeate fluorine resins		
Linearity	±1%F.S.(at25°C)		
Hysteresis	±1%F.S. (at25°C)		
Temperature Effects	±0.05%F.S./°C		
Output	Current	DC 4 to 20 mA	
	Voltage	DC 1 to 5 V	
* Standard Pressure Display Range	-10 to 525 kPa (differs depending on rated pressure)		
Display Accuracy	±1%F.S. ±1digit		
Upper/Lower Limit Output Difference	2%F.S.		
Pressure Setting Points	2 points (upper limit, lower limit)		
Upper/Lower Limit Setting Accuracy	±1%F.S.		
Upper/Lower Limit Setting Output	Max. 30V, 80 mA (NPN open collector)		
Power Supply	DC 12 to 24 V±10%		
Current Consumption	Max.100 mA (12V), Max.70 mA (24V)		
Environmental Temperature Range	15 to 50°C		
Fluid Temperature Range	15 to 80°C		
Standard Cable	6-core shielded cable (AWG 28), OD 4.8 mm 2 m (PTFE sheath)		
Wetted Parts Material	PTFE, PFA (differs by model)		
Main Color	Gray		
Protection Class	IP65		

\* Pressure display (for 0 to 500 kPa)

Lower limit display: -10 kPa (-2% F.S. of rated output)

Upper limit display: 525 kPa (+5% F.S. of rated output)

**Outer Dimensions**

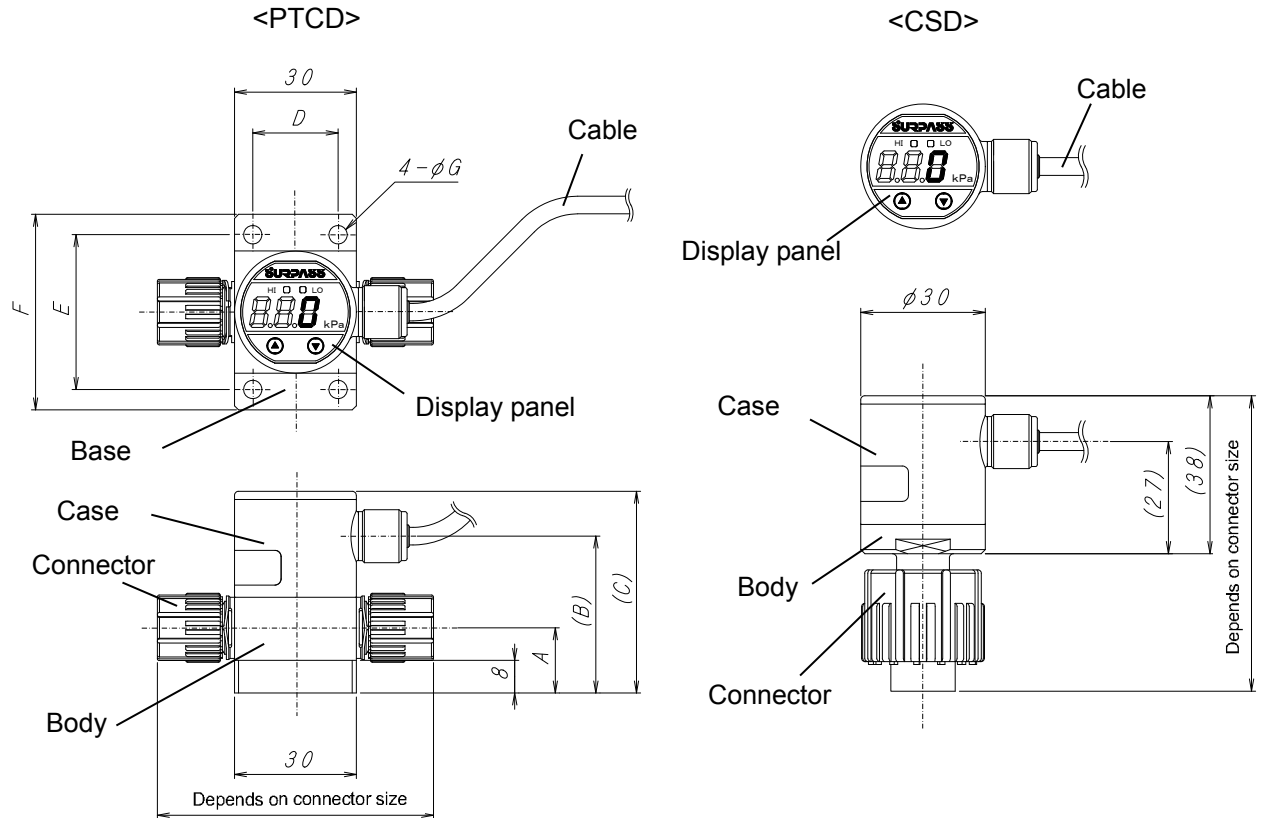

Model	A	(B)	(C)	D	E	F	$\phi G$
PTCD-12	16	(39)	(50)	24	27	33	3.5
PTCD-13	20	(45.5)	(56.5)	21	38	48	4.5
PTCD-14	20	(47)	(58)	21	38	48	4.5
PTCD-16	24	(62)	(73)	21	42	50	4.5

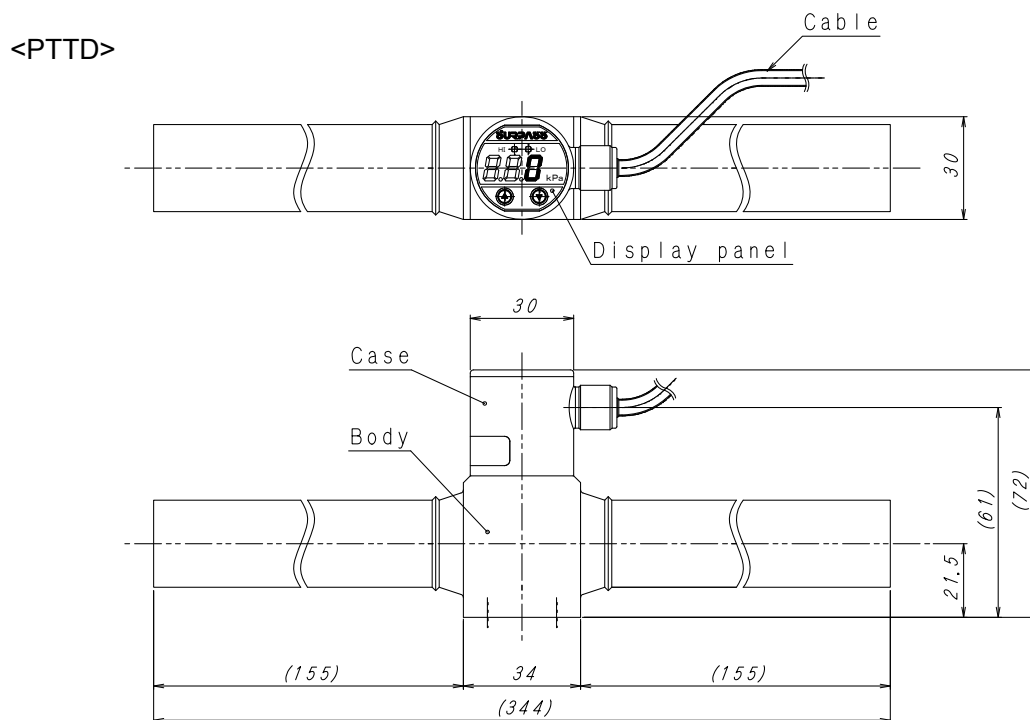

## Names and Functions of Display Panel

- HI LED**
- Lights up when the measured pressure reaches the upper limit setting.
  - Flashes during zero adjust.

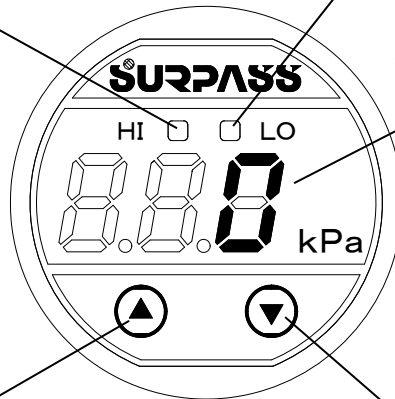

- LO LED**
- Lights up when the measured pressure reaches the lower limit setting.
  - Flashes during zero adjust.

- Digital display unit**
- Displays the measured pressure.
  - Displays the upper/lower limit settings.

- UP button**
- Used to set the upper limit.
  - Used to perform zero adjust.
  - Used to reset errors that occur during zero adjust.

- DOWN button**
- Used to set the lower limit.
  - Used to perform zero adjust.

## Mounting and Connecting the Connector Parts

<Inline type>

If you wish to anchor your Pressure Sensor, always use the mounting holes in the base.

In order to install connector parts correctly, always refer to the relevant catalog or operation manual issued by the connector manufacturer.

<Straight type>

When connecting the connector parts, clamp the sides of the body (WAF: 27 mm) with the dedicated tool for the connector, and tighten the connector while preventing the body from turning.

In order to install connector parts correctly, always refer to the relevant catalog or operation manual issued by the connector manufacturer.



### WARNING

- When mounting connector parts, comply with the instructions issued by each connector manufacturer. Loose connections may result in disconnection or chemical leakage. The use of dangerous chemicals, solvents, and gases may cause physical impairment.
- Refrain from excessive tightening of the connector parts. Otherwise, damage to the pressure sensor and connector may occur and result in liquid leakage. The use of dangerous chemicals, solvents, and gases may cause physical impairment.



### CAUTION

- When tightening the connector, do not tighten it while holding or rotating the case. The case may damage the product when it is rotating.
- The case and the operation panel of the product is not revolving. The case may damage the product when it is rotating.
- Please do not rotate the pressure sensor after tightening the connector. If change the direction, Please loosen the connector.

## Points to Observe When Installing

To prevent erroneous operation or premature wear, do not install in:

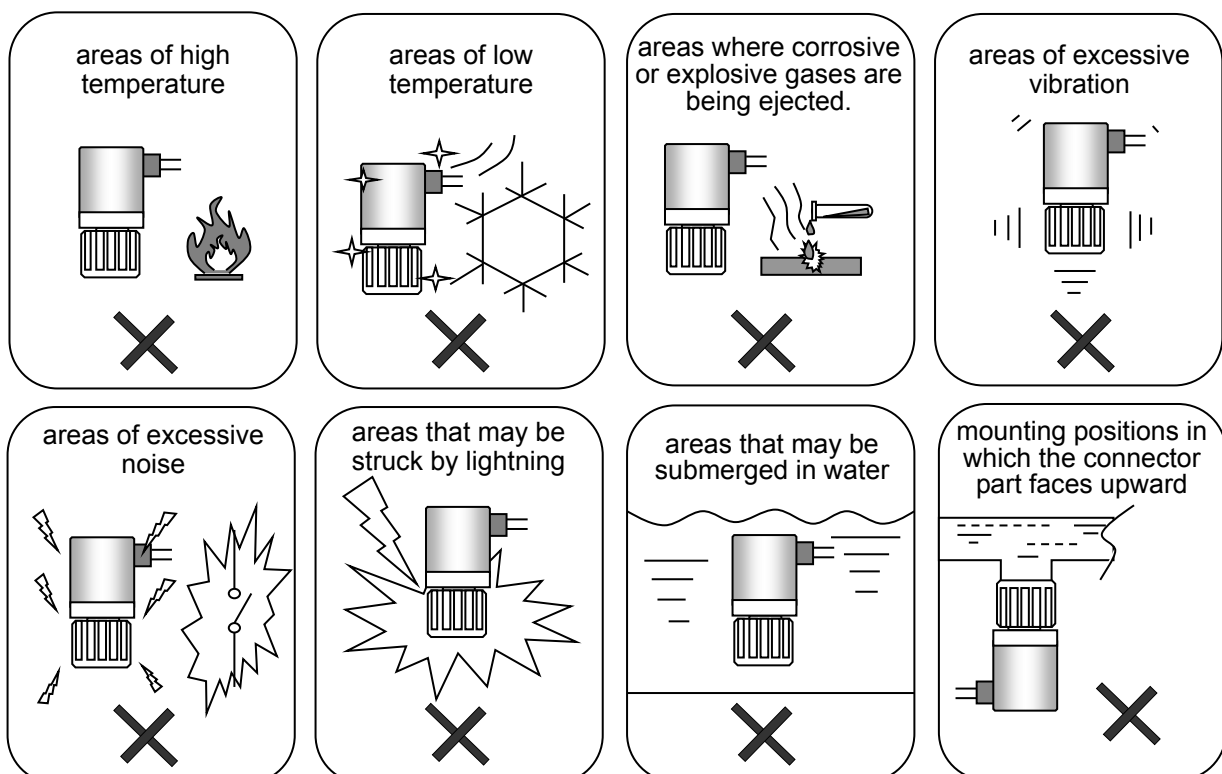

## Wiring

Observe these precautions to connect the leads correctly.

### ⚠ CAUTION

- Never do wiring work when power supply is on. Doing so may cause electrical shock.
- Do not pull or bend the cable forcibly. It may cause breakage of the cable, electrical shock, or fire. In addition, pulling the cable forcibly rotates the case, which may result in the damage to the product.
- Make sure to connect all leads correctly. Failure to do so may cause the product to fail.  
Do not connect a power supply to Blue line and Black line, because they are connected inside. If they are connected to a power supply, a product breaks down.
- If you are using a commercially available switching regulator as a power supply, always ground it to an F.G. terminal. If electricity leaks to earth, it may cause electrical shock.
- Connect the shield on shielded cables to the frame ground as necessary.

<Pressure sensor wiring diagram>

#### Current output

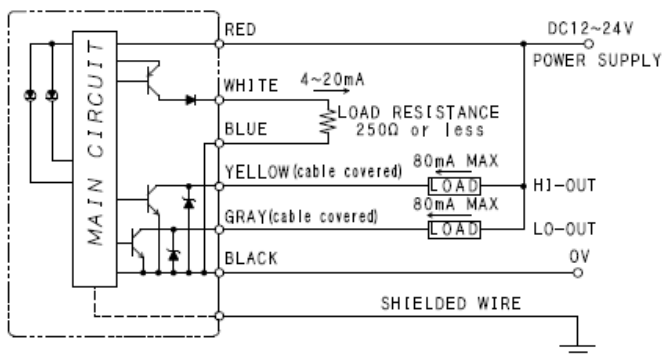

#### Voltage output

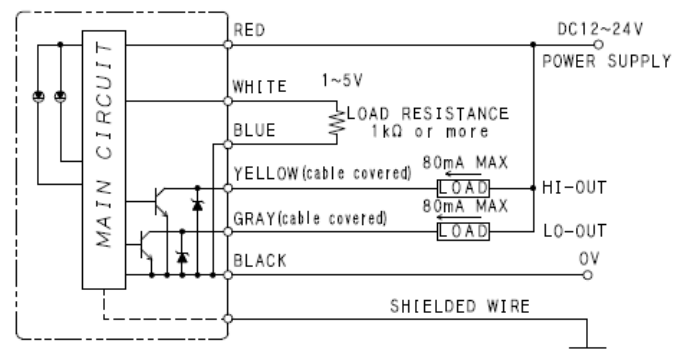

## How to Use

Check the following items before using your Pressure Sensor.

- (1) Make the Pressure Sensor open to the atmosphere (0kPa) and apply the power.
- (2) Warm up your equipment by running "on empty" for approximately 20 minutes after power-on.
- (3) Check to see that your displayed pressure and analog output values are as shown below.

Displayed pressure: 0 kPa  
Analog output values  
Current: 4 mA  
Voltage: 1 V

- (4) If your displayed pressure or analog output values are not as shown below, you will need to do zero adjust following the instructions in "How to Do Zero Adjust".

Displayed pressure: 0 kPa  
Analog output values  
Current: 4 mA  
Voltage: 1 V

## Setting the Upper/Lower Limits

### ◇ Setting the Upper Limit

- (1) Press and hold the ▲ button for at least three seconds.
  - The HI LED will light up, and an “H” will appear in the display.

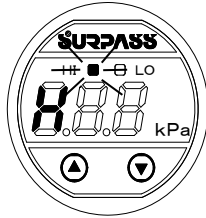

- When you release your hand from the ▲ button, the display will change to the current setting.

Factory setting: OFF

- \* Pressing the ▲ button beyond the maximum rated pressure value causes the display to change to OFF.

- (2) Adjust the upper limit setting by pressing the ▲▼ buttons.

- \* The upper limit is within the rated pressure range.

- The numbers can be fast forwarded or reversed by holding down on the ▲ or ▼ button.

- (3) After releasing the ▲ or ▼ button, the display will return to measuring mode in five seconds.

### ◇ Setting the Lower Limit

- (1) Press and hold the ▼ button for at least three seconds.
  - The LO LED will light up, and an “L” will appear in the display.

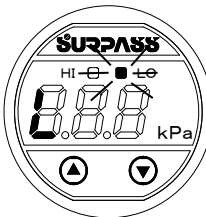

- When you release your hand from the ▼ button, the display will change to the current setting.

Factory setting: OFF

- \* Pressing the ▼ button beyond the minimum rated pressure value causes the display to change to OFF.

- (2) Adjust the lower limit setting by pressing the ▲▼ buttons.

- \* The lower limit is within the rated pressure range.

- The numbers can be fast forwarded or reversed by holding down on the ▲ or ▼ button.

- (3) After releasing the ▲ or ▼ button, the display will return to measuring mode in five seconds.

## How to Do Zero Adjust

- (1) Make sure that your Pressure Sensor is opened to the atmospheric state.
- (2) Press and hold the ▲ and ▼ buttons simultaneously for at least three seconds.

Zero adjust conditions:

- Open to the atmospheric state.
- Pressure fluctuation must be within  $\pm 1\%$  F.S.

- The HI/LO LEDs must be flashing and the “ZA” will appear in the display.

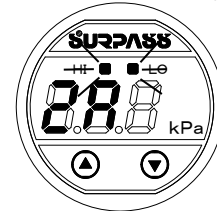

- When you release your hand from the ▲ and ▼ buttons, zero adjust will start.

## ! CAUTION

Before doing the zero adjust procedure, Pressure Sensor is opened to the atmospheric state

- (3) After the zero adjust is complete, the HI and LO LEDs will change from a flashing state to a constantly lit state. The pressure sensor has returned to measurement mode.

### [Zero adjust error]

If the HI and LO LEDs keep flashing after at least three seconds from the time zero adjust started, it is the indication of an zero adjust error.

- When zero adjust is in progress, an error will occur if the pressure in your piping system fluctuates by  $\pm 1\%$  F.S. or more. The error is displayed as “EUL”.

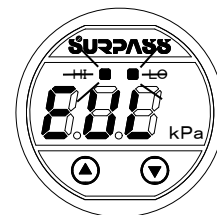

- To reset the error, press and hold the ▲ button for at least one second.

After the error resets, redo the zero adjust procedure from Step (1).



Periodically provide the ZERO point adjustment.



## Maintenance and Inspection

The Pressure Sensor should be inspected regularly, about twice a year depending on the usage.

During the regular inspection, check the

- appearance
- corrosion, clogging, leakage, etc., from the connector parts.

The Pressure Sensor should be flushed periodically if using liquids that crystallize easily.

<Safety Notes on Maintenance and Inspection>

 <b>DANGER</b> unless these precautions are not obeyed!	
<ul style="list-style-type: none"> <li>● If using dangerous chemicals, solvents, gases, etc., make sure to wear protective, chemical resistant gear (protective gloves, mask, and clothing) to protect your entire body. Ejected liquids may result in physical impairment.</li> <li>● Before disconnecting this product from the piping system, make sure the line is depressurized. Otherwise, the fluid inside will eject and may result in physical impairment.</li> <li>● When replacing parts, or when performing maintenance or inspection, turn off the switch, and release the fluid inside the piping to depressurize the line. Otherwise, the fluid inside will eject and may result in physical impairment.</li> </ul>	

## Error Display

Display	Cause	Countermeasure
UUU	The measured pressure is 5% F.S. above the rated pressure.	Reduce the pressure in your piping system to fall within the rated pressure range.
LLL	The measured pressure is -2% F.S. below the rated pressure.	Increase the pressure in your piping system to fall within the rated pressure range.
EUL	During the zero tracking process, the pressure in your piping system fluctuated by $\pm 1\%$ F.S. or more.	Press and hold the ▲ button for 1 or more second to reset the error. Adjust the pressure in your piping so that it fluctuates less than $\pm 1\%$ F.S. Then repeat zero tracking.

## In Case of Breakdown

Symptom	Cause	Countermeasure
Digital display is blank (Does not power up)	Incorrect wiring.	Check the wiring diagram and correct the wiring.
	Incompatible power, voltage.	Check the power supply and voltage.
Digital display does not indicate 0 kPa.	The equipment has not been warmed up.	Warm up the equipment for at least 20 minutes.
	Zero point is off.	Adjust the zero point.
Zero adjust fails.	The pressure inside your piping system is fluctuating.	Vent the piping system to atmospheric state.
No analog output.	Incorrect wiring.	Check the wiring diagram and correct the wiring.
The digital display and/or analog output is unstable.	There is noise-generating equipment nearby.	Move the noise-generating equipment from the vicinity.
	The shield wire is not grounded.	Ground the shield wire.
	The pressure inside your piping system is fluctuating.	Stop the pressure inside your piping system from fluctuating.
No upper/lower limit output	Incorrect wiring.	Check the wiring diagram and correct the wiring.
	The upper or lower limit settings are incorrect.	Set the upper and lower limit settings correctly.

Notify your nearest sales office for problems not listed above.

**Notes on Warranty**

The warranty runs for one year after the day when Surpass Industry products are delivered from Surpass factory in Japan. In case Surpass Industry should agree in writing that the defects in performance or material were caused by faulty design or workmanship of Surpass Industry, replacement products will be supplied free of charge. This warranty shall not be applied to any defects caused by misuse, alteration, neglectful treatment, and neglect of our recommendations or instructions.

In addition, we are not be liable to any direct or consequential loss, damage, and personal injury due to an unauthorized usage in combination with other products and an improper usage outside of the specifications. Our product warranty shall be limited to replacement of product.

Replacement with expense to the purchaser shall be applied to the followings:

- Any defective products caused by usage that is not described in the instruction Manual.
- Any defective products caused by neglectful treatment.
- Any defective products caused by decomposition, alteration, and improper adjustment or repair.
- Any defects of products caused by acts of God including natural disaster or fires.
- Consumables and accessories

# **SURPASS**

**Surpass Industry Co., Ltd.**

2203 Shimooshi, Gyoda-shi, Saitama 361-0037 Japan

TEL: +81 48 554 9760 FAX: +81 48 554 9906

URL: <http://www.surpassindustry.co.jp>

© 2009-2020 Surpass Industry Co.,Ltd. All rights reserved.